

OM-9

High-grade operating microscope supports a wide range of surgical needs

- Supports a wide range of operations, from cataract surgery and retinal vitrectomy to out-patient procedures
- Apochromatic lens and red reflex illumination deliver a clear field of view
- Flexible customization with a rich variety of options

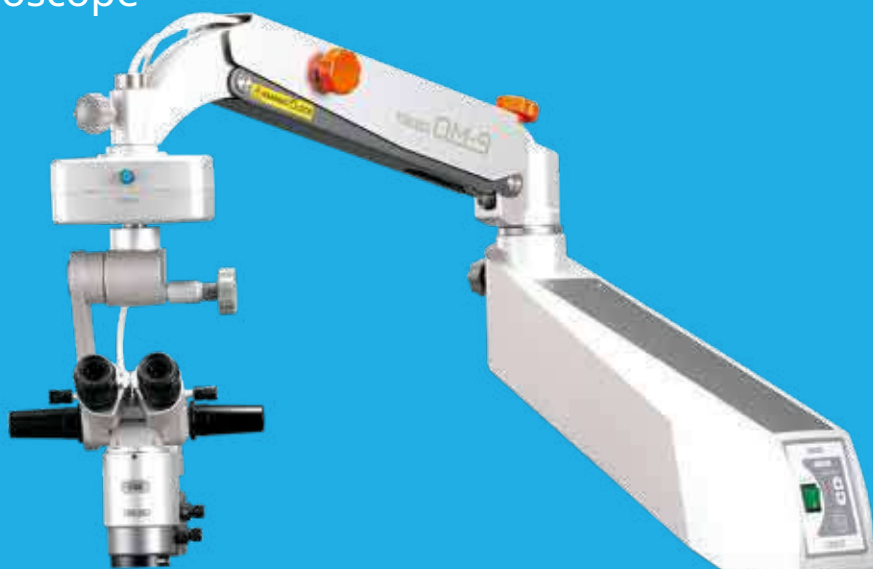

Serving Your Vision

TAKAGI ophthalmic devices, proudly made in Japan since 1955.

The red reflex illumination mechanism is combined with a high-luminance LED and apochromatic lens. A high-grade operating microscope that allows to select required functions.

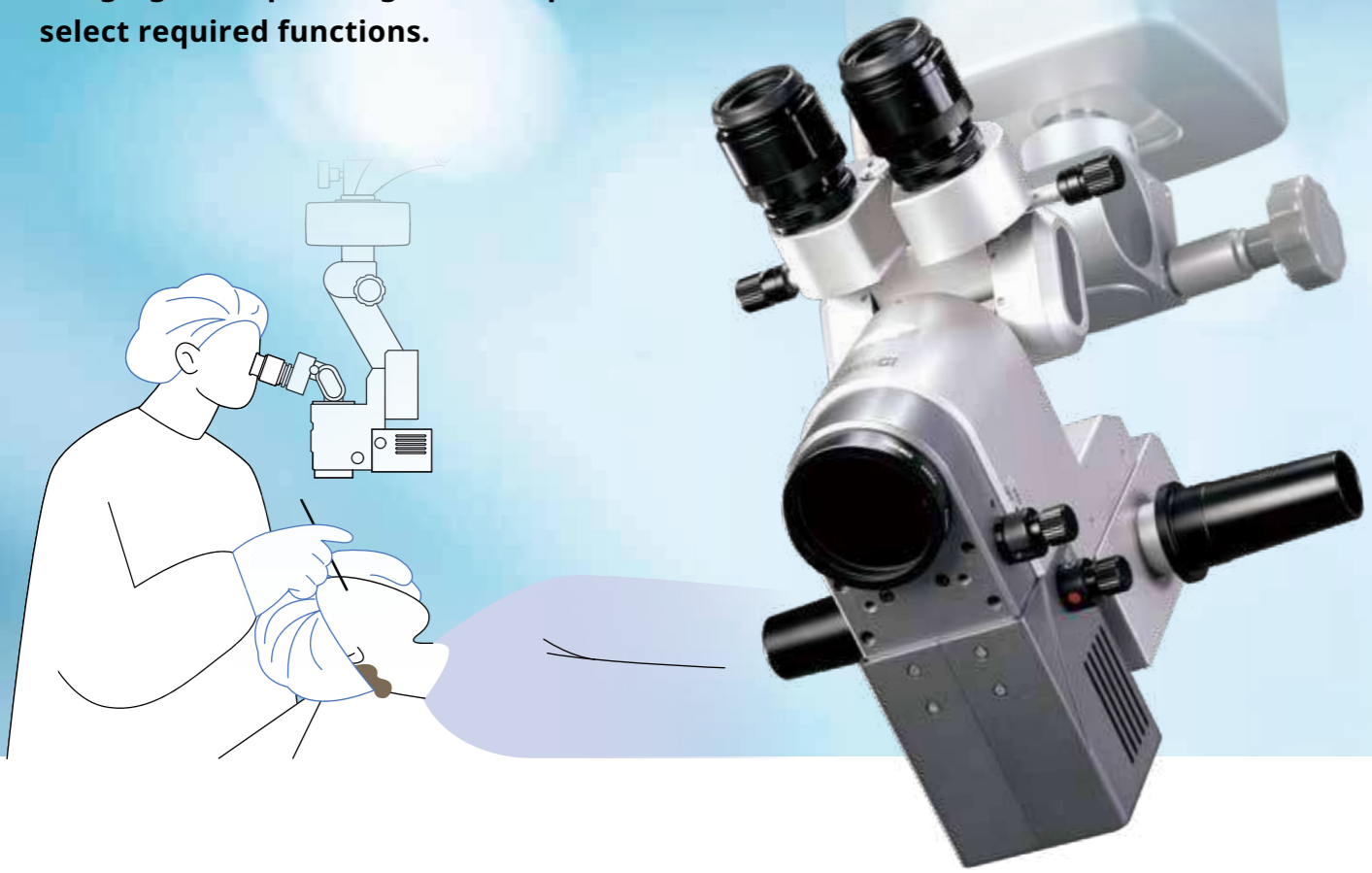

Enhances usability for the surgeon, increase surgical efficiency

Selection of three configurations according to need

The OM-9 is available in three different specifications based on the combination of coupling, microscope, and binocular tube, allowing the surgeon to choose the configuration that best suits the needs.

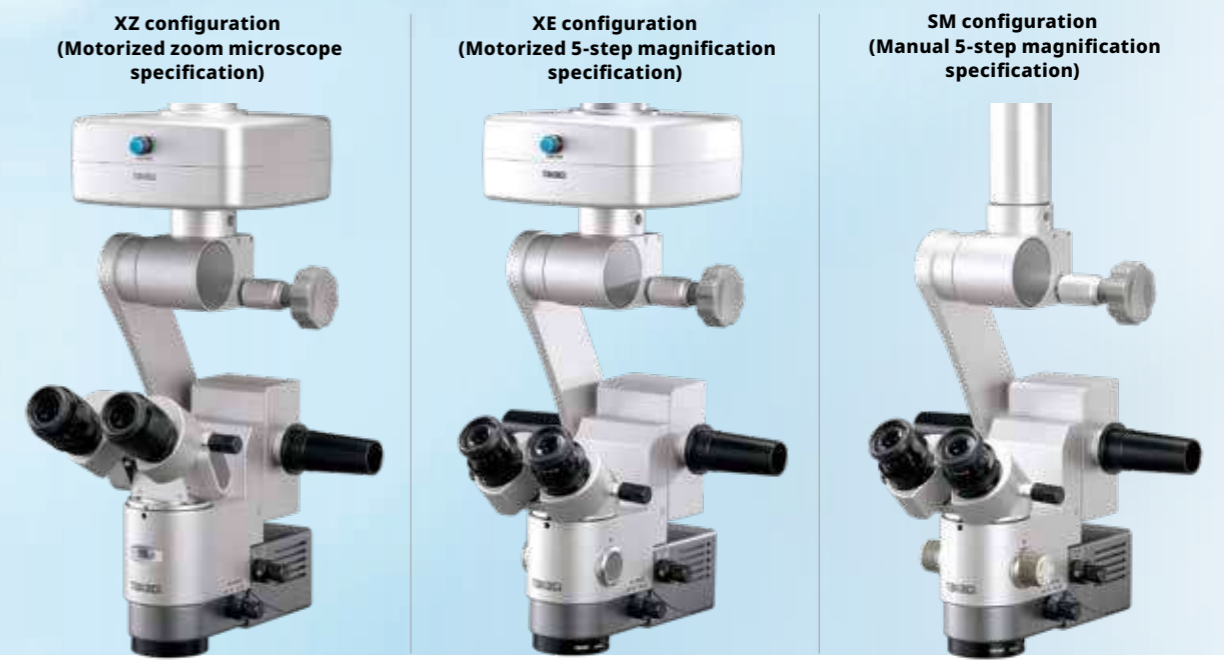

Coupling	X-Y coupling	X-Y coupling	Straight coupling
Microscope	Motorized zoom magnification (zoom ratio 1:5)	5-step motorized magnification	5-step manual magnification
Binocular tube	Tilttable	Fixed at 45° angle	Fixed at 45° angle

*Configurations other than the three basic types listed above may be possible. For further details, please contact our sales department.

Optimized optical design meets a wide range of demands, from ophthalmic surgery to out-patient procedures

The optimized optical design and high-quality optical system maximize visibility during surgery and allow tiny tissues and structures to be identified clearly.

Combination of a red reflex illumination mechanism and high-luminance LED

The illumination system adopts high-luminance LED light to focus on contrast and color reproduction. The red reflex illumination mechanism provides ample reflected light from the fundus, resulting in high-quality red reflex and stereoscopic observation images, which are essential for cataract surgery.

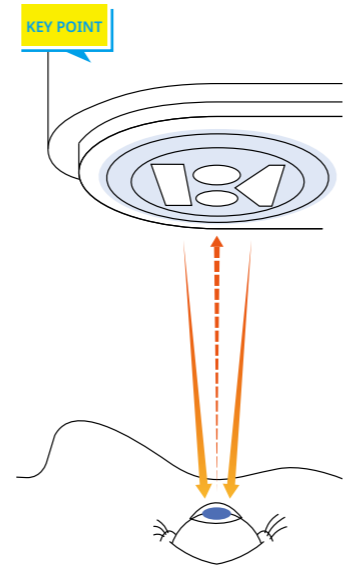

The illumination from two mirrors entering the pupil (simultaneously) provides ample red reflex illumination from the fundus and uniformly illuminates the lens.
*The image is for illustrative purposes only.



CCC (Continuous Curvilinear Capsulorhexis)

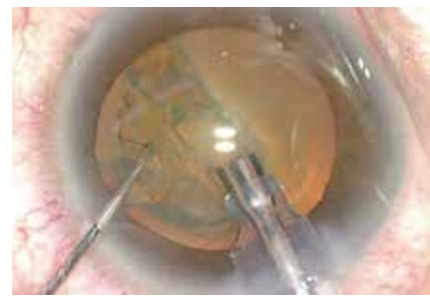

PEA (Phacoemulsification and aspiration)

Comfortable operations and a natural posture for peace of mind even during long surgical operations

Magnification adjustment and layout both optimized for the surgeon

The XZ and XE specifications have a foot controller that allows smooth adjustment of magnification. Furthermore, the pedal position can be freely customized to create the optimal layout for operation by the surgeon.



Ergonomic design

The XZ specification is equipped with binocular tubes which angle can be adjusted up to 90 degrees. This allows the surgeon to keep a comfortable posture and maintain concentration, even during long surgical operations.



Learn more



Specifications

Model name		OM-9 Operating Microscope		
		XZ	XE	SM
Microscope	Magnification changer	Motorized zoom magnification (zoom ratio 1:5)	5-step motorized magnification	5-step manual magnification
	Objective lens	F = 200 mm (apochromatic correction optical system)		
	Eyepieces	10x (high-eyepoint & wide field)	16x (high-eyepoint & wide field)	
	Binocular tube	Tilttable binocular tubes F = 170 mm	45° inclined binocular tubes F = 125 mm	
	Total magnifications	4.1x-20.4x	4x / 6x / 10x / 16x / 25x	
	X-Y movement (motorized)	± 25 mm in each direction with speed 3 mm/sec and centering control		
Illumination	Light source	LED		
	Filters	Heat-absorbing / Blue correction/ Blue cut / Retina shield		
Arm & Base	Type	Floor stand with 4 casters and 2 stoppers		
	Maximum load tolerance on arm	Up to 3.2 kg of accessories		
Power Unit	Power supply	AC 100-230 V, 50/60 Hz		
	Power input	70 VA		
Weight (excl. options)		90.6 kg	90.2 kg	89.7 kg

Dimensions

Dimensions (mm)

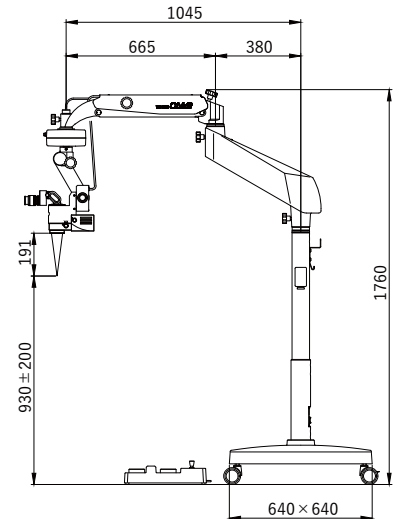

Flexible customization with a rich variety of options

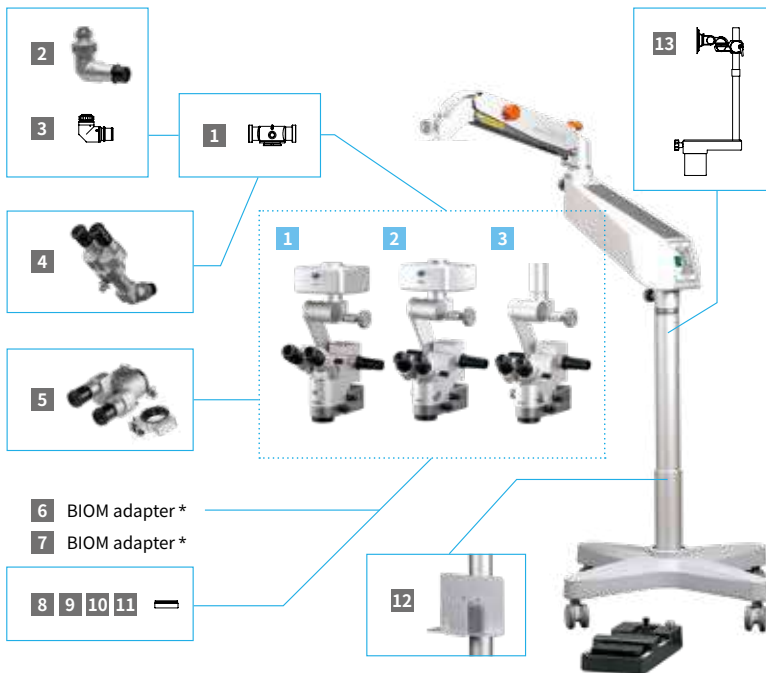

Accessories

1	O11-03	Beam Splitter	A camera can be attached (beam ratio: surgeon 80%, camera 20%)
2	O08-11	TV Camera Adapter	A C-mount compatible TV camera can be attached (F = 50 mm, with iris)
3	O08-22	TV Camera Adapter	A C-mount compatible TV camera can be attached (F = 50 mm)
4	O06-19SE	Coaxial Binocular Microscope	Provides the same observation image viewed by the surgeon
5	O06-20SE	Assistant Scope	Mounts at a 26° angle to the main microscope, providing stereoscopic vision and independent focus adjustment, enabling the assistant to achieve an optimal view
6	O06-25	BIOM Adapter	OCULUS BIOM* ¹ adapter for retina and vitreous surgery can be attached
7		EIBOS Adapter	Haag-Streit EIBOS* ² adapter for retina and vitreous surgery can be attached
8	O14-22	Objective Lens	F = 175 mm
9	O14-24	Objective Lens	F = 250 mm
10	O14-25	Objective Lens	F = 300 mm
11	O14-26	Objective Lens	F = 350 mm
12	O06-23	Camera Control Rack	Camera control unit can be stowed
13	O06-22	Monitor Arm	An LCD monitor can be attached

Configuration selection

1	X-Y coupling, Motorized zoom magnification, Tilttable binocular tube
2	X-Y coupling, 5-step motorized magnification, 45° angle binocular tube
3	Straight coupling, 5-step manual magnification, 45° angle binocular tube

*¹ BIOM and OCULUS are registered trademarks of OCULUS Optikgeräte GmbH.

*² EIBOS and Haag-Streit are registered trademarks of Haag-Streit AG.

*Please contact our Sales Department for details about BIOM adapters.

To ensure safe and correct handling please read the user manual before using.

● Description and appearance as detailed in this brochure may be subject to change as improvements are made to products.

● Colors of product(s) in brochure may slightly differ from actual product(s) due to lighting situation when photographed or print conditions.

For The Americas, Asia-Pacific & Middle East Takagi Seiko Co., Ltd.

330-2 Iwafune, Nakano-shi, Nagano-ken, 383-8585, Japan
TEL : +81(0)269-22-6094 URL : <https://www.takagi-j.com>



For Europe & Africa

Takagi Ophthalmic Instruments Europe Ltd.

Citylabs 1.0, Nelson Street, Manchester, M13 9NQ, UK
TEL : +44 (0)161 273 6330 URL : <https://www.takagieurope.com>



Your local distributor