

# 4ZL 2ZL / 2ZL BG

Highly functional model designed for efficient examinations,  
with a bright, clear field of view and smooth operability

- Provides a natural and clear field of view
- Efficiently designed for close-at-hand operations
- Clear image due to LED background illumination



*Serving Your Vision*

TAKAGI ophthalmic devices, proudly made in Japan since 1955.

The high-luminance LED light source and multi-level magnification allow clear observation of affected areas. Lesions and foreign matter can be identified clearly and in detail, supporting more accurate diagnosis.

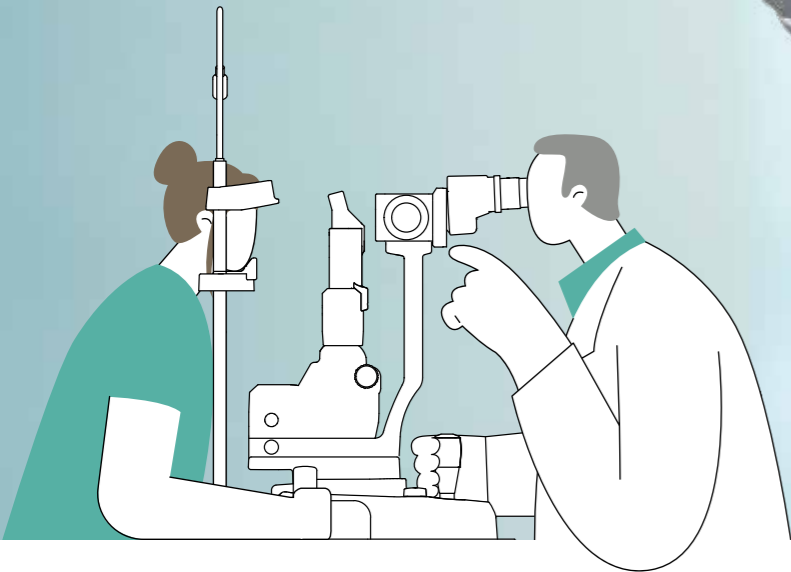

## All controls are located at doctor's fingertips for a friendly examination environment for both doctors and patients.

To reduce the burden on doctors during long examinations and minimize fatigue, the design focuses on ease of use, from the size and positioning of the operating parts to their operational feel. All controls are located at the doctor's fingertips and can be operated without moving the arm. This model uses an energy-saving LED light source which provides stable brightness over a long service life. This allows a design with built-in cables and reduces heat generation, contributing to enhanced patient safety.



The design consists of parts such as a large-diameter dimmer knob arranged functionally around the joystick for easy operation with one hand.



The size and feel of the large-diameter control knob are optimally designed for comfortable operation.



The front lens can be held in a stable position using the finger rest of the forehead rest. This makes observations easier and reduces the burden on the doctor's arms, while also minimizing contact with patients.

## Optical design supports accurate diagnosis

A high-luminance LED light source is used to enable affected areas to be observed clearly and in detail for more accurate diagnosis. Color and light unevenness are reduced to provide a natural and clear field of view.



Filter not in use

Since the intrinsic blue light of LED is rich, the light scattering makes areas such as the cornea, aqueous humor, lens, and vitreous humor clearly visible.

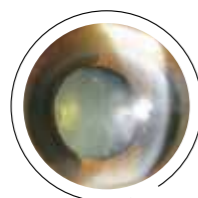

Blue correction filter in use

The blue light characteristic of LEDs is reduced to make the light easier on the eye. Its natural color tone, resembling that of a halogen lamp, reduces eye strain and delivers a well-balanced observation image.

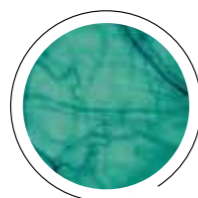

Green filter in use

Since red blood vessels and bleeding are shown in black, the contours of tiny lesions are highlighted to provide clear observation images in fine detail.

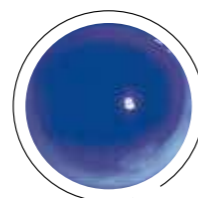

Blue filter in use

When combined with fluorescein staining, this model is effective not only for ocular tonometry, but also to clarify the condition of the cornea and tear fluid, and conduct fitting checks for contact lenses.

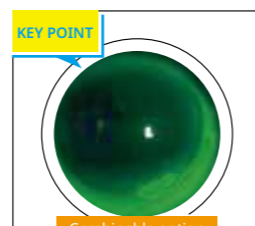

Blue filter and yellow filter combination in use\*

The accuracy of diagnosis is further boosted by a wide variety of options, such as a yellow filter that increases contrast for fluorescent observations using fluorescein staining.

\*Photo provided by: Dr. Toru Noda, Department of Ophthalmology, NHO Tokyo Medical Center

## Vivid image output makes explaining to patients easier

The background illumination uses an LED with the same color temperature as the slit illumination to obtain a clear image without impairing the color balance. This makes the entire eye clearly visible, enabling patients to intuitively understand the location and condition of the affected area.

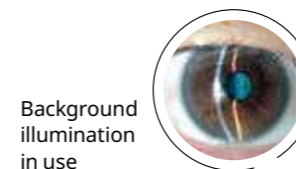

Background illumination in use

Combinable options



A camera can be connected for imaging by attaching a TAKAGI combination or camera adapter. A TAKAGI digital camera is also available.



Simply pressing a button once to capture an image while operating the joystick.

## 2ZL offers great value

The 2ZL offers similar design and features as the 4ZL, but for more affordable price.

Total magnifications

2ZL 10x / 16x / 25x

\*If you need background illumination, please select the 2ZL BG.



Learn more



## Specifications

Model name		4ZL Slit Lamp Microscope		2ZL Slit Lamp Microscope	
				Standard	BG
Microscope	Type	Galilean binocular stereo microscope			
	Magnification changer	5-position rotating drum		3-position rotating drum	
	Eyepiece	16x wide field, high-eyepoint			
	Total magnifications	6.3x / 10x / 16x / 25x / 40x		10x / 16x / 25x	
	Stereo angle	10°			
Illumination Unit	Slit image width	Continuously variable 0-14 mm (circular at 14 mm)			
	Slit image length	Continuously variable 1-14 mm			
	Filters	Blue / Green (red-free) / Blue correction			
	Light source	LED (3500K)			
Power Unit	Power supply	AC 100-240 V (±10%), 0.4-0.2 A			
	Power input	DC 5 V 2 A			
Weight (excl. power adapter & options)		11.5 kg	11 kg	11.5 kg	

## Dimensions

Dimensions (mm)

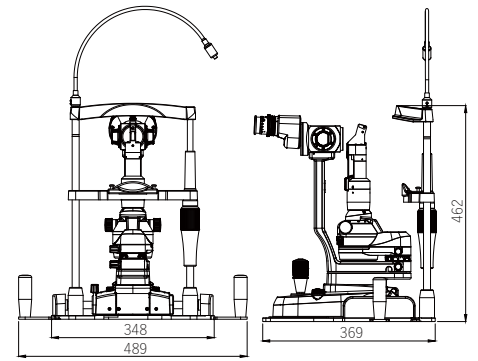

## Flexible customization with a rich variety of options

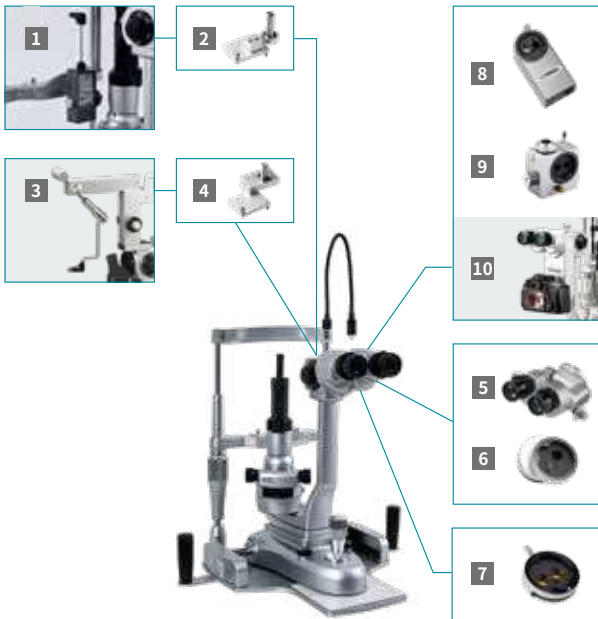

## Accessories

1	AT-1	Applanation Tonometer	Supports a wide range of slit lamps made by TAKAGI
2	TB700	Tonometer Base	For AT-1 attachment
3	AT-2	Applanation Tonometer	Specifically designed for TAKAGI slit lamps 4ZL / 2ZL
4	TB2	Tonometer Base	For AT-2 attachment
5	O12-20	Tiltable Binocular Tube	Enhances neck and shoulder comfort
6	S06-59	13-degree Inclined Adapter	Enhances neck and shoulder comfort
7	S06-44	Yellow Filter	Enhances contrast for fluorescence observation
8	TD12 / EyeCAM	Digital Camera & Image Filing Software	Versatile, high-performance camera for capturing high-resolution slit lamp images
9	S10-17	Combination TV Camera Adapter	Integrates the beam splitter, camera adapter and yellow filter (beam ratio: examiner 70%, camera 30%)
10	TD-2	Digital Camera Adapter	A digital SLR camera can be attached (beam ratio: examiner 40%, camera 60%)



To ensure safe and correct handling please read the user manual before using.

- Description and appearance as detailed in this brochure may be subject to change as improvements are made to products.
- Colors of product(s) in brochure may slightly differ from actual product(s) due to lighting situation when photographed or print conditions.

### For The Americas, Asia-Pacific & Middle East Takagi Seiko Co., Ltd.

330-2 Iwafune, Nakano-shi, Nagano-ken, 383-8585, Japan  
TEL : +81(0)269-22-6094 URL : <https://www.takagi-j.com>

### For Europe & Africa

### Takagi Ophthalmic Instruments Europe Ltd.

Citylabs 1.0, Nelson Street, Manchester, M13 9NQ, UK  
TEL : +44 (0)161 273 6330 URL : <https://www.takagieurope.com>



Takagi Seiko Co., Ltd.



Your local distributor