

700GL 700GL NSW

Vivid and deep images
for even more accurate and efficient diagnosis

- Clear and stereoscopic observation images
- NSW functions further increase the precision of observations
- Provides an efficient examination environment



Serving Your Vision

TAKAGI ophthalmic devices, proudly made in Japan since 1955.

A slit lamp is an essential instrument for the diagnosis of various eye diseases. The advanced optical performance and operability of the flagship 700GL model support doctors as they conduct examinations. The 700GL NSW is also equipped with innovative NSW function to enable observations in even greater detail.

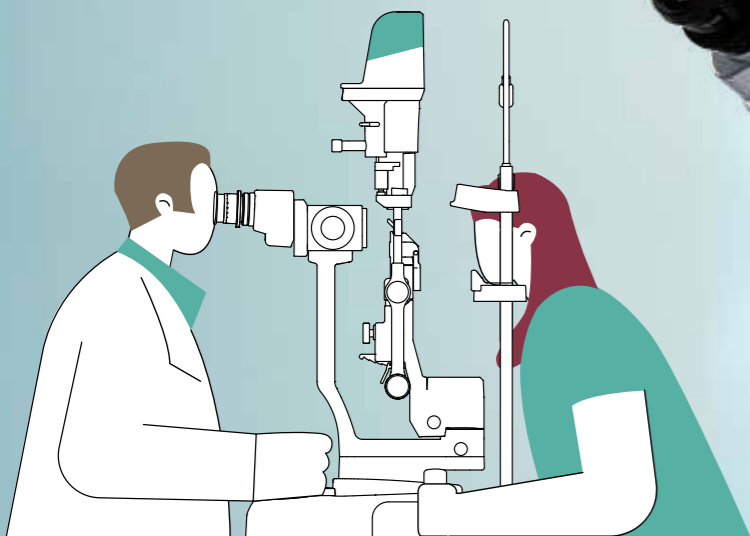

700GL NSW

NSW function

In contrast to the 10° stereo angle of the 700GL, an angle of 4.1° is adopted for the NSW, ensuring a wider stereoscopic vision area. This makes it easier to observe the fundus in detail for highly accurate diagnosis.

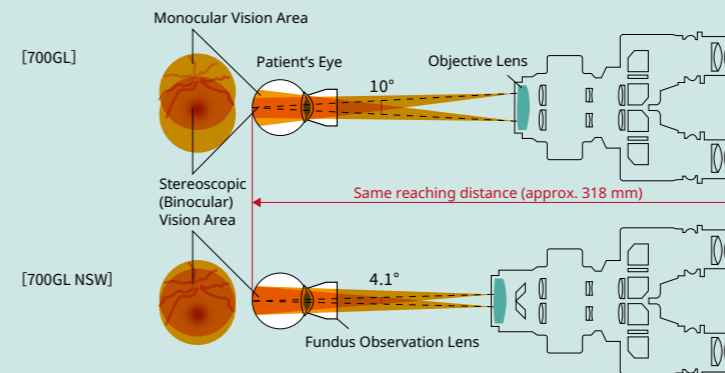

Switching to the NSW functions is easy. Simply press the knob at the bottom of the objective lens.

*700GL NSW is a factory option specification. Please note that the standard 700GL cannot be modified/converted to 700GL NSW after purchase. NSW is an acronym of "Narrow angle," "Stereo," and "Wide viewer."
*The image is for illustrative purposes only.

Ergonomic design × LED = Efficient examination environment, friendly to both doctors and patients

To reduce the burden on doctors during long examinations and minimize fatigue, the design focuses on ease of use, from the size and positioning of the operating parts to their operational feel. This model uses an energy-saving LED light source which provides stable brightness over a long service life. This allows a design with built-in cables and reduces heat generation, contributing to enhanced patient safety.

Highly accurate examinations and diagnoses with a more natural stereoscopic effect

The inter-optical path distance of 22 mm and the sharp slit illumination that uses a high-luminance LED with a 3500 K color temperature produce a clear observation image with a stereoscopic effect from the anterior eye parts to the fundus. Lesions and foreign matter can be identified clearly and in detail, supporting more accurate diagnosis.



Filter not in use

Since the intrinsic blue light of LED is rich, the light scattering makes areas such as the cornea, aqueous humor, lens, and vitreous humor clearly visible.

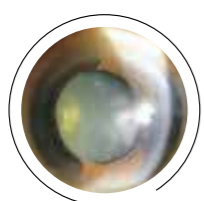

Blue correction filter in use

The blue light characteristic of LEDs is reduced to make the light easier on the eye. Its natural color tone, resembling that of a halogen lamp, reduces eye strain and delivers a well-balanced observation image.



Blue cut filter in use

Retina strain is reduced by restricting light scattering and delivering the light as far as the fundus, while minimizing the effects of blue light.

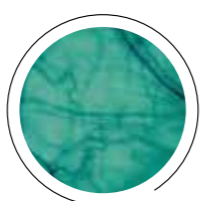

Green filter in use

Since red blood vessels and bleeding are shown in black, the contours of tiny lesions are highlighted to provide clear observation images in fine detail.

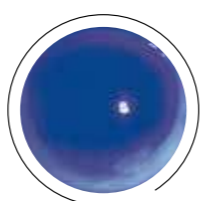

Blue filter in use

When combined with fluorescein staining, this model is effective not only for ocular tonometry, but also to clarify the condition of the cornea and tear fluid, and conduct fitting checks for contact lenses.



Blue filter and yellow filter combination in use*

The accuracy of diagnosis is further boosted by a wide variety of options, such as a yellow filter that increases contrast for fluorescent observations using fluorescein staining.

*Photo provided by: Dr. Toru Noda, Department of Ophthalmology, NHO Tokyo Medical Center



The design consists of parts such as a large-diameter dimmer knob arranged functionally around the joystick for easy operation with one hand.



The size and feel of the large-diameter control knob are optimally designed for comfortable operation.



The front lens can be held in a stable position using the finger rest of the forehead rest. This makes observations easier and reduces the burden on the doctor's arms, while also minimizing contact with patients.

Vivid image output makes explaining to patients easier

The background illumination uses an LED with the same color temperature as the slit illumination to obtain a clear image without impairing the color balance. This makes the entire eye clearly visible, enabling patients to intuitively understand the location and condition of the affected area.

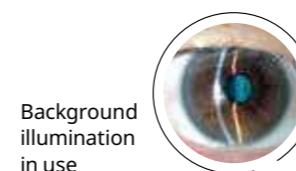

Background illumination in use

Combinable options



A camera can be connected for imaging by attaching a TAKAGI combination or camera adapter. A TAKAGI digital camera is also available.



Simply pressing a button once to capture an image while operating the joystick.

Learn more



Specifications

Model name		700GL Slit Lamp Microscope	
		Standard	NSW
Microscope	Type	Galilean binocular stereo microscope	
	Magnification changer	5-position rotating drum	
	Eyepiece	16x wide field, high-eyepoint	12.5x wide field, high-eyepoint
	Total magnifications	6.3x / 10x / 16x / 25x / 40x	6x / 9x / 15x / 24x / 37x
	Stereo angle	10°	4.1° (prism in), 12° (prism out)
Illumination Unit	Slit image width	Continuously variable 0-14 mm (almost circular at 14 mm)	
	Slit image length	Continuously variable 1-14 mm	
	Filters	Blue / Green (red-free) / Blue correction / Blue cut	
	Light source	LED (3500K)	
Power Unit	Power supply	AC 100-240 V (±10%), 0.4-0.2 A	
	Power input	DC 5 V 2 A	
Weight (excl. power adapter & options)		12.5 kg	

Dimensions

Dimensions (mm)

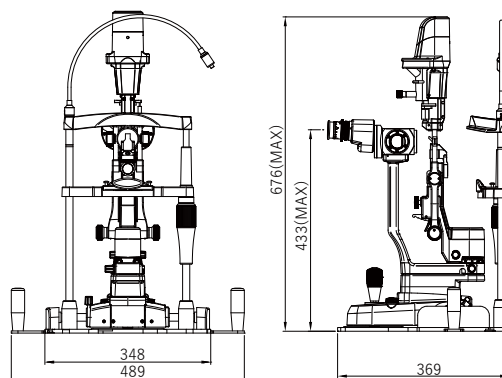

Flexible customization with a rich variety of options

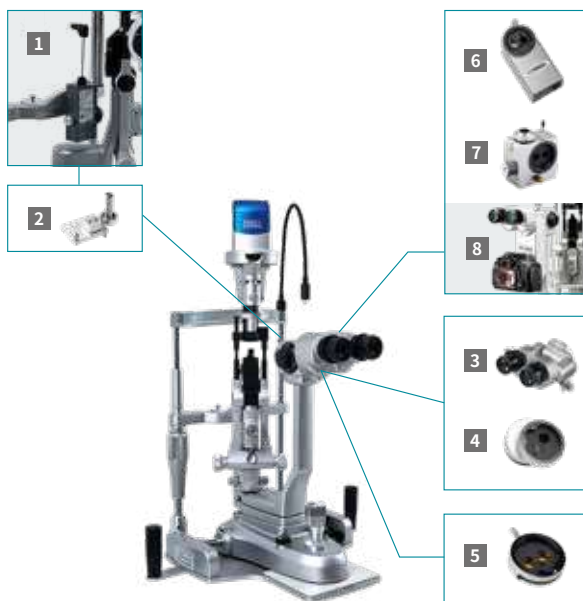

Accessories

1	AT-1	Applanation Tonometer	Supports a wide range of slit lamps made by TAKAGI
2	TB700	Tonometer Base	For AT-1 attachment
3	O12-20	Tiltable Binocular Tube	Enhances neck and shoulder comfort
4	S06-59	13-degree Inclined Adapter	Enhances neck and shoulder comfort
5	S06-44	Yellow Filter	Enhances contrast for fluorescence observation
6	TD12 / EyeCAM	Digital Camera & Image Filing Software	Versatile, high-performance camera for capturing high-resolution slit lamp images
7	S10-17	Combination TV Camera Adapter	Integrates the beam splitter, camera adapter and yellow filter (beam ratio: examiner 70%, camera 30%)
8	TD-2	Digital Camera Adapter	A digital SLR camera can be attached (beam ratio: examiner 40%, camera 60%)

To ensure safe and correct handling please read the user manual before using.

- Description and appearance as detailed in this brochure may be subject to change as improvements are made to products.
- Colors of product(s) in brochure may slightly differ from actual product(s) due to lighting situation when photographed or print conditions.

For The Americas, Asia-Pacific & Middle East

Takagi Seiko Co., Ltd.

330-2 Iwafune, Nakano-shi, Nagano-ken, 383-8585, Japan
TEL : +81(0)269-22-6094 URL : <https://www.takagi-j.com>



Your local distributor

For Europe & Africa

Takagi Ophthalmic Instruments Europe Ltd.

Citylabs 1.0, Nelson Street, Manchester, M13 9NQ, UK
TEL : +44 (0)161 273 6330 URL : <https://www.takagieurope.com>